

Sense and MomAbility's
12 Days of Christmas

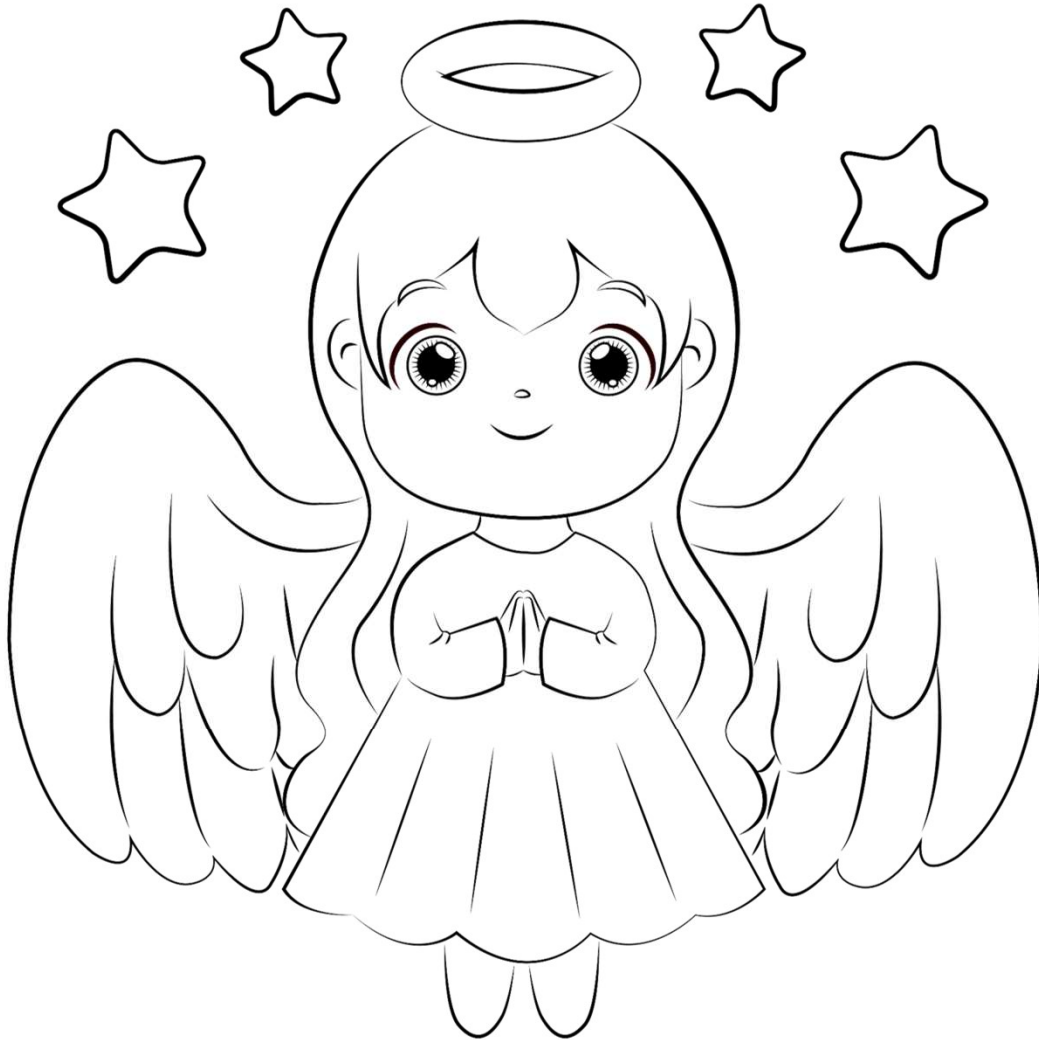

A is for

angel



Sense and MomAbility's
12 Days of Christmas



B is for

bells

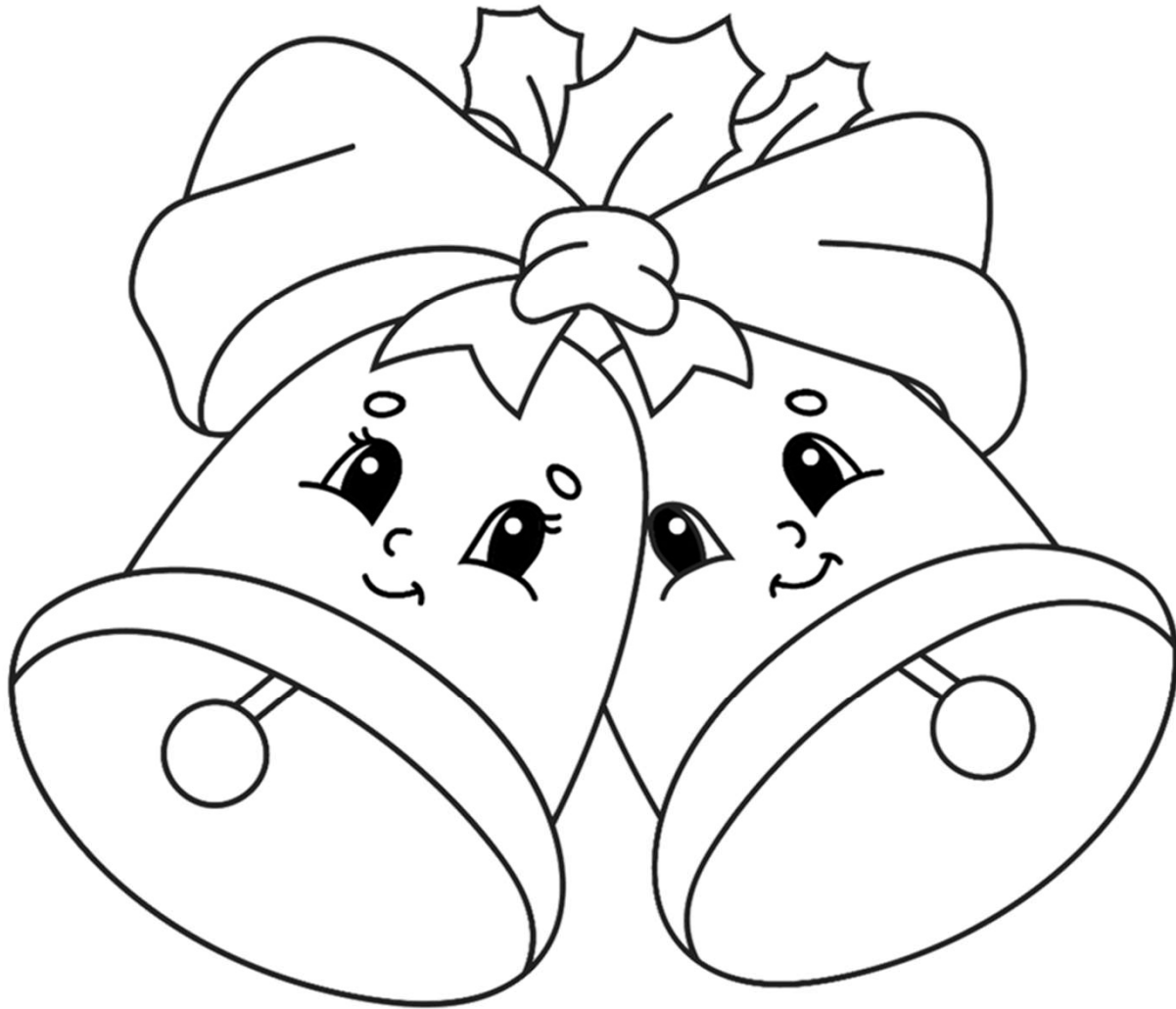



Sense and MomAbility's
12 Days of Christmas



C is for

cookies





Sense and MomAbility's
12 Days of Christmas



D is for

deer



Sense and MomAbility's
12 Days of Christmas



E is for

elf



Sense and MomAbility's
12 Days of Christmas



F is for

fireplace





Sense and MomAbility's
12 Days of Christmas



G is for

gingerbread

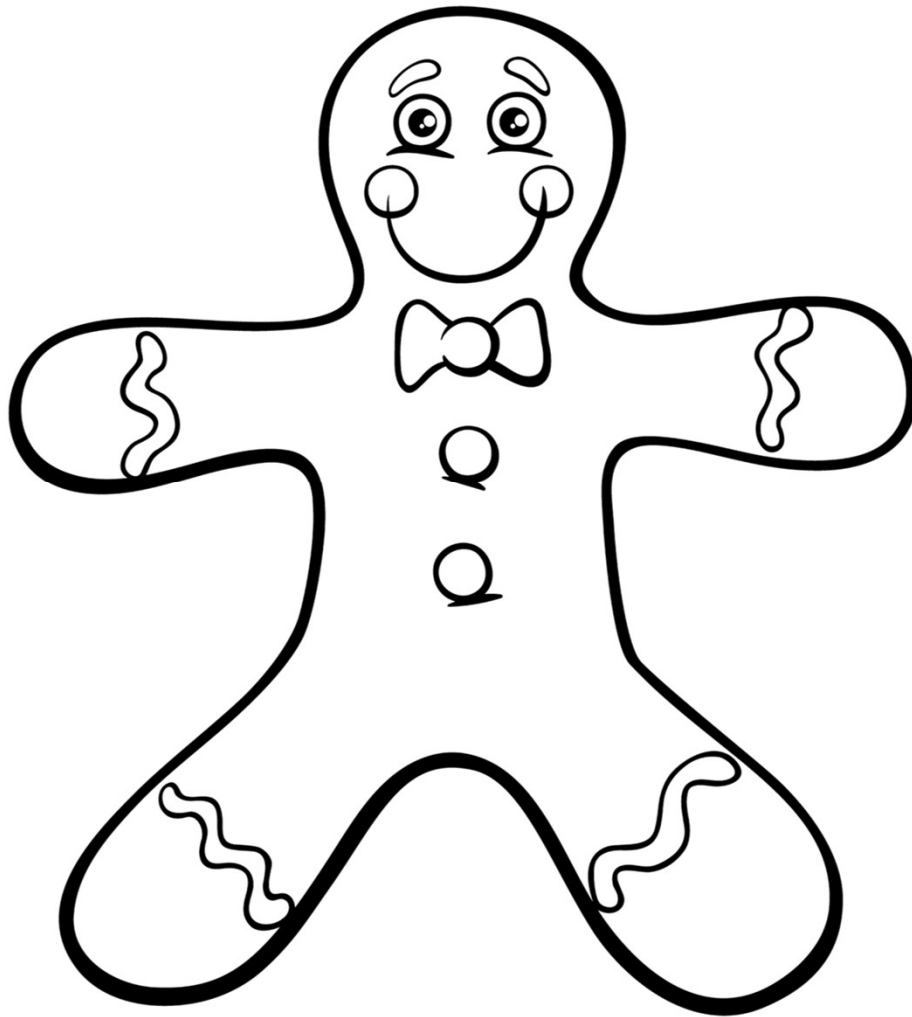



Sense and MomAbility's
12 Days of Christmas



H is for

hot chocolate



Sense and MomAbility's
12 Days of Christmas



I is for

ice skating

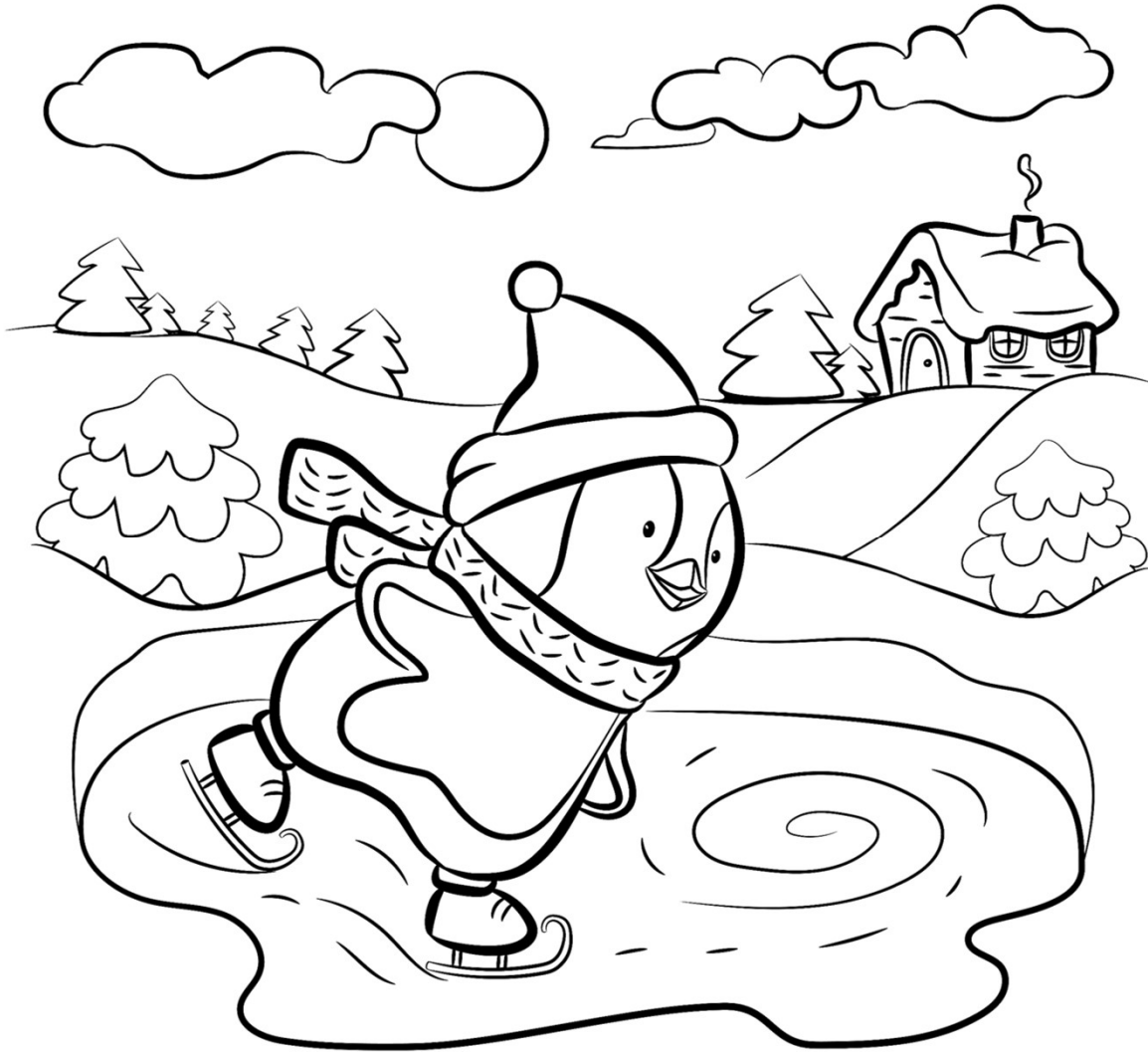



Sense and MomAbility's
12 Days of Christmas



J is for

jacket





Sense and MomAbility's
12 Days of Christmas



K is for

kings

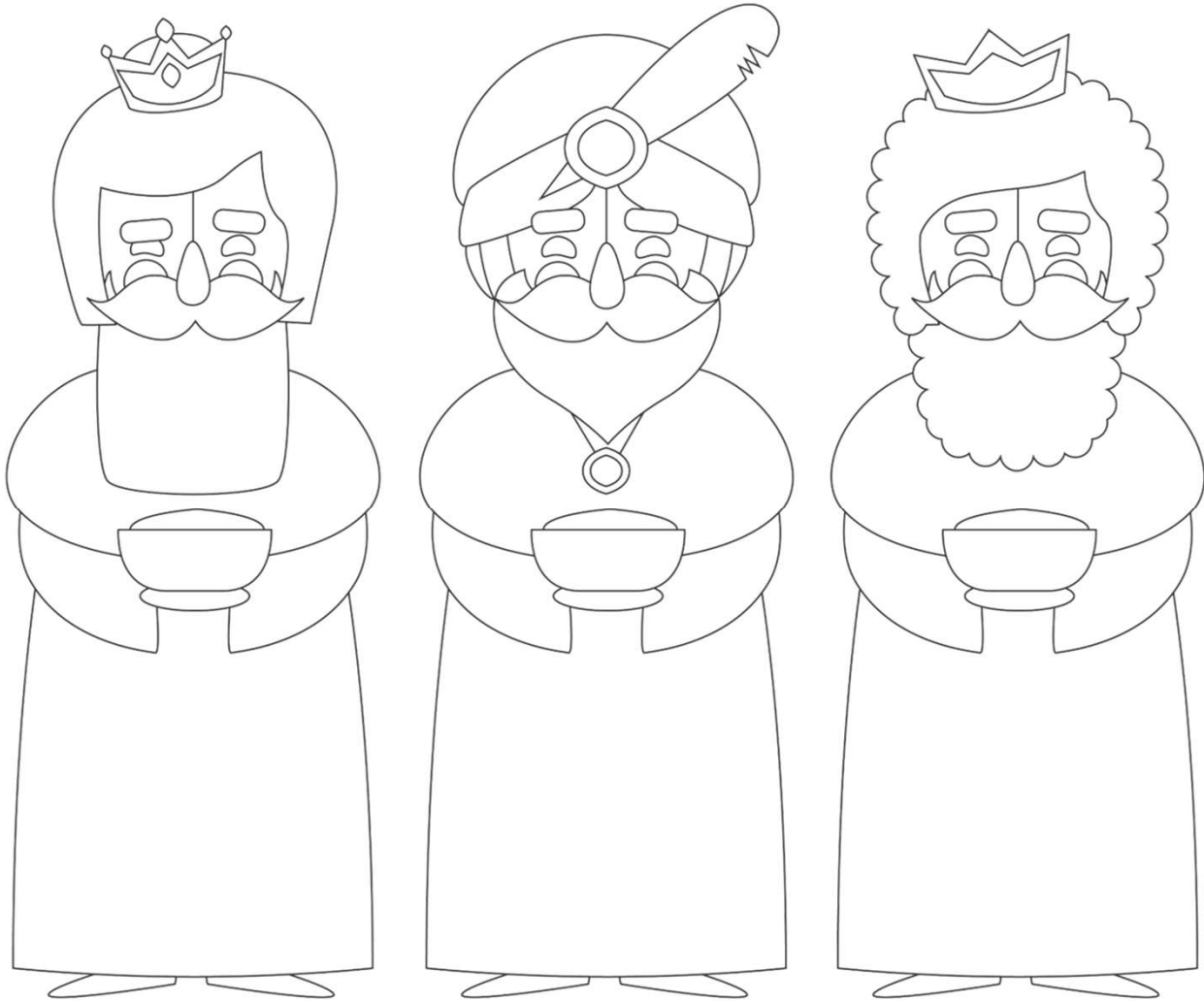



Sense and MomAbility's
12 Days of Christmas



L is for

lights

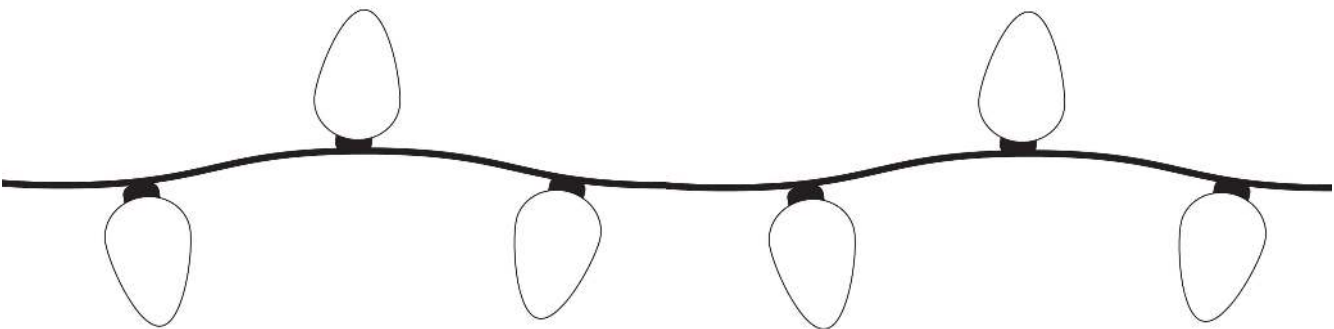
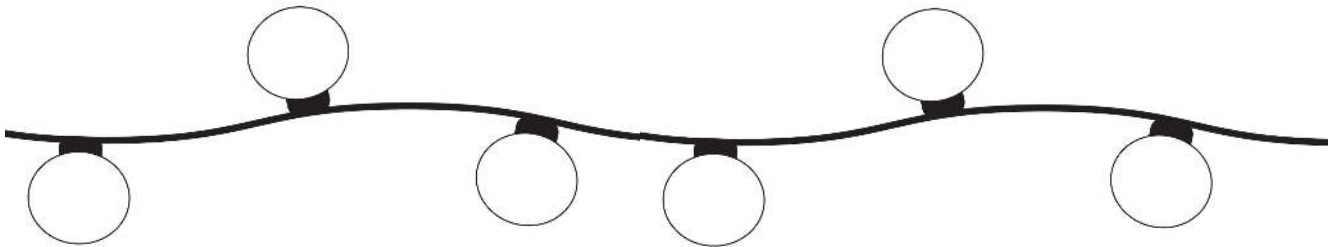



Sense and MomAbility's
12 Days of Christmas



M is for

mittens

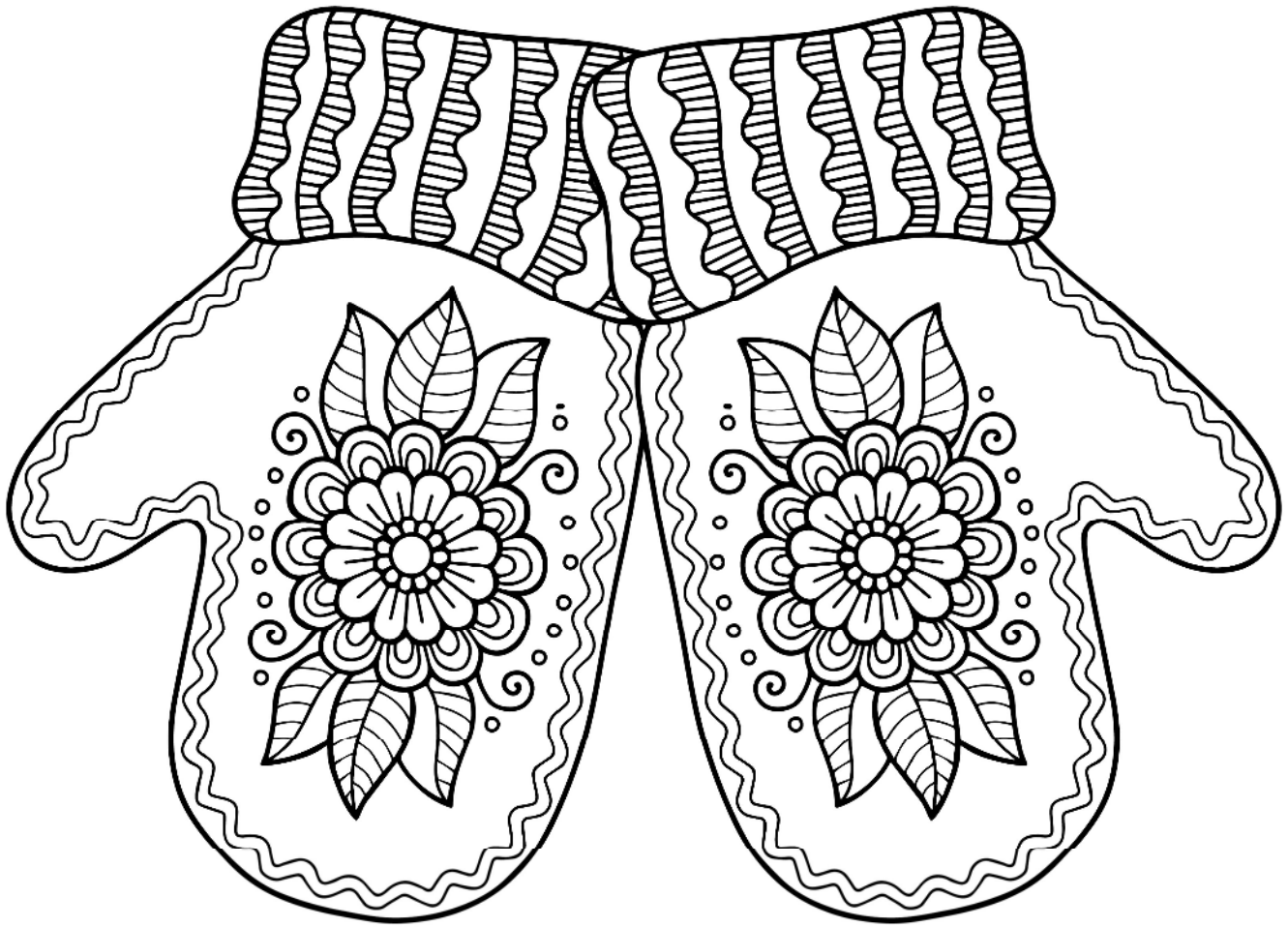

Sense and MomAbility's
12 Days of Christmas



N is for

nutcracker

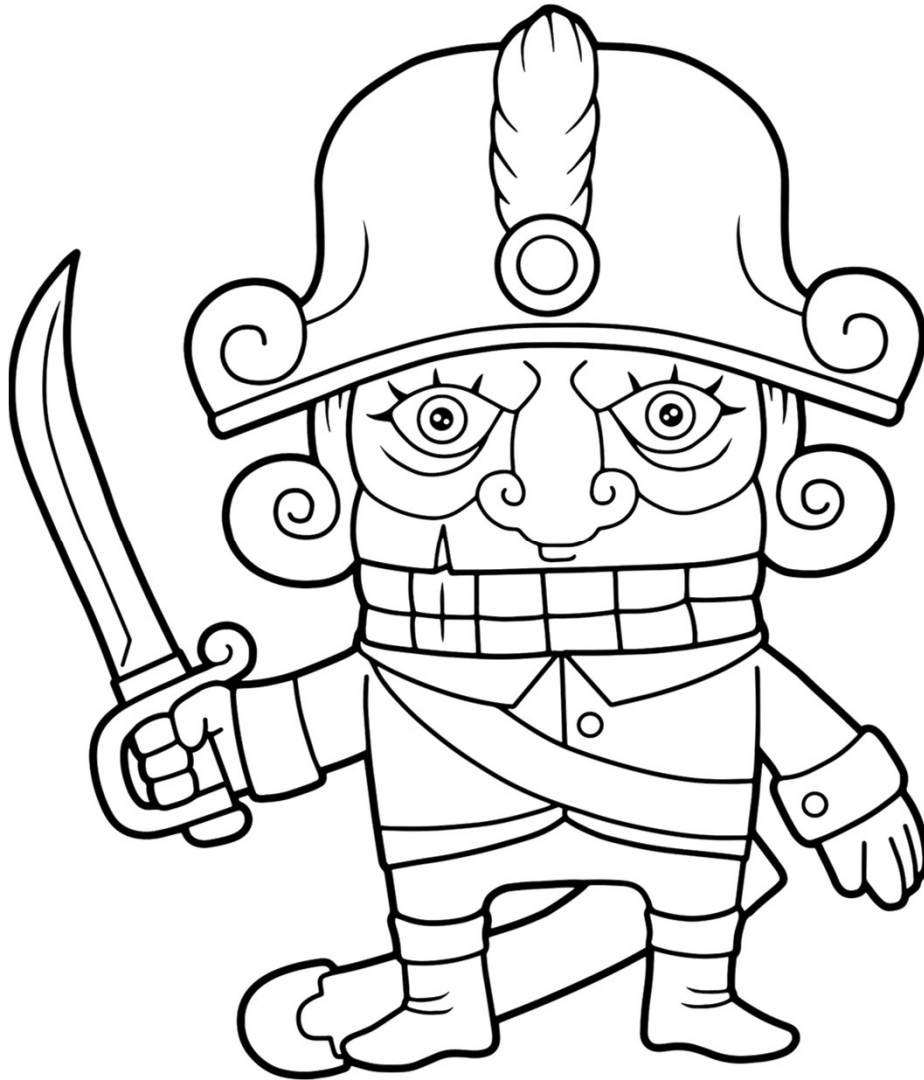



Sense and MomAbility's
12 Days of Christmas



O is for

ornament

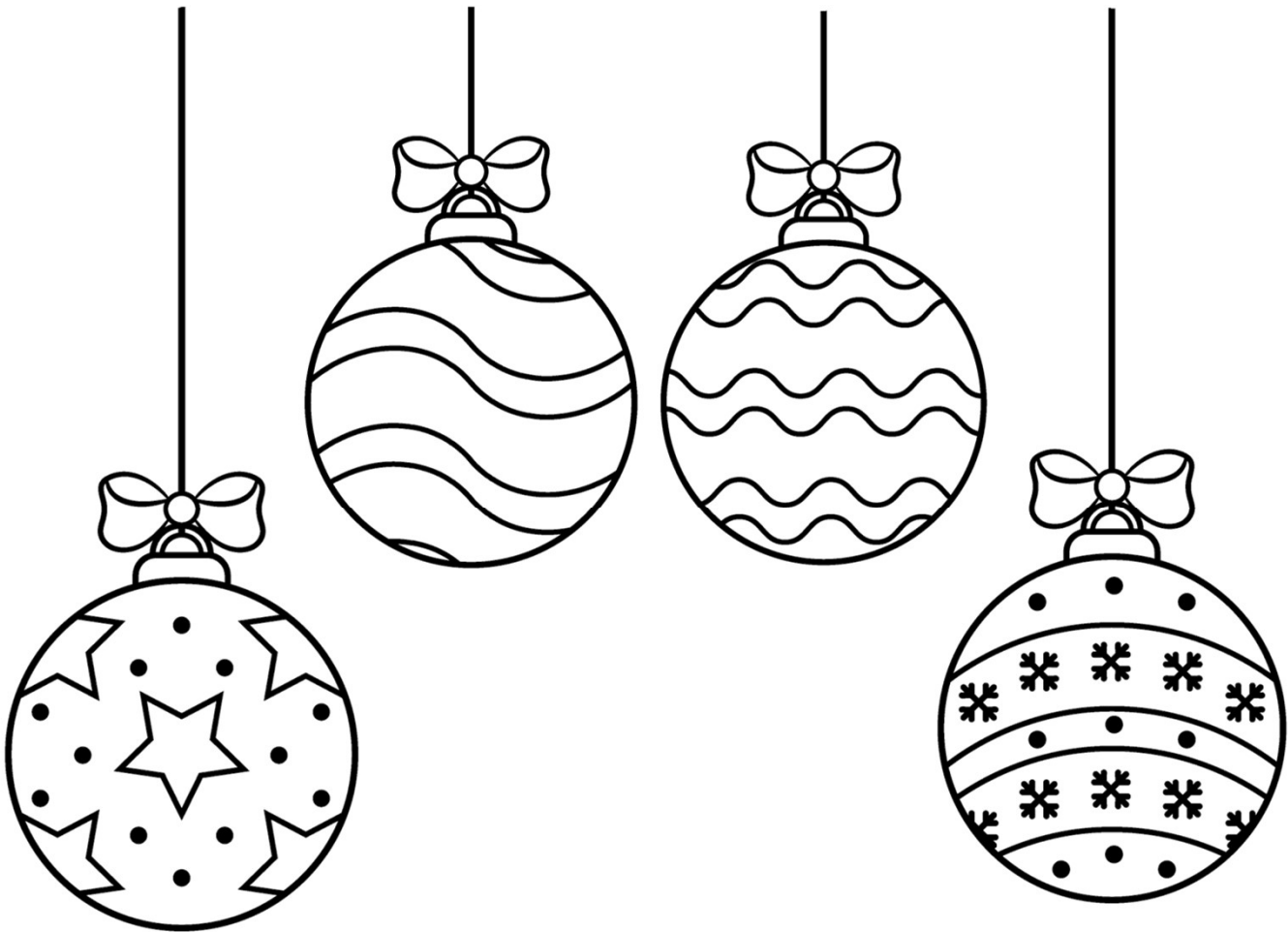



Sense and MomAbility's 12 Days of Christmas



P is for

presents

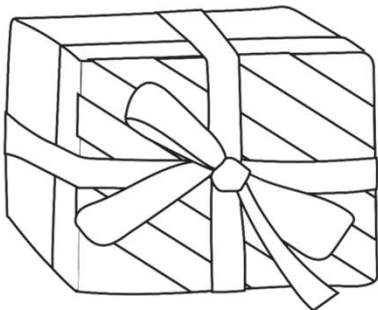

Santa
is coming



Sense and MomAbility's
12 Days of Christmas



Q is for

quilt

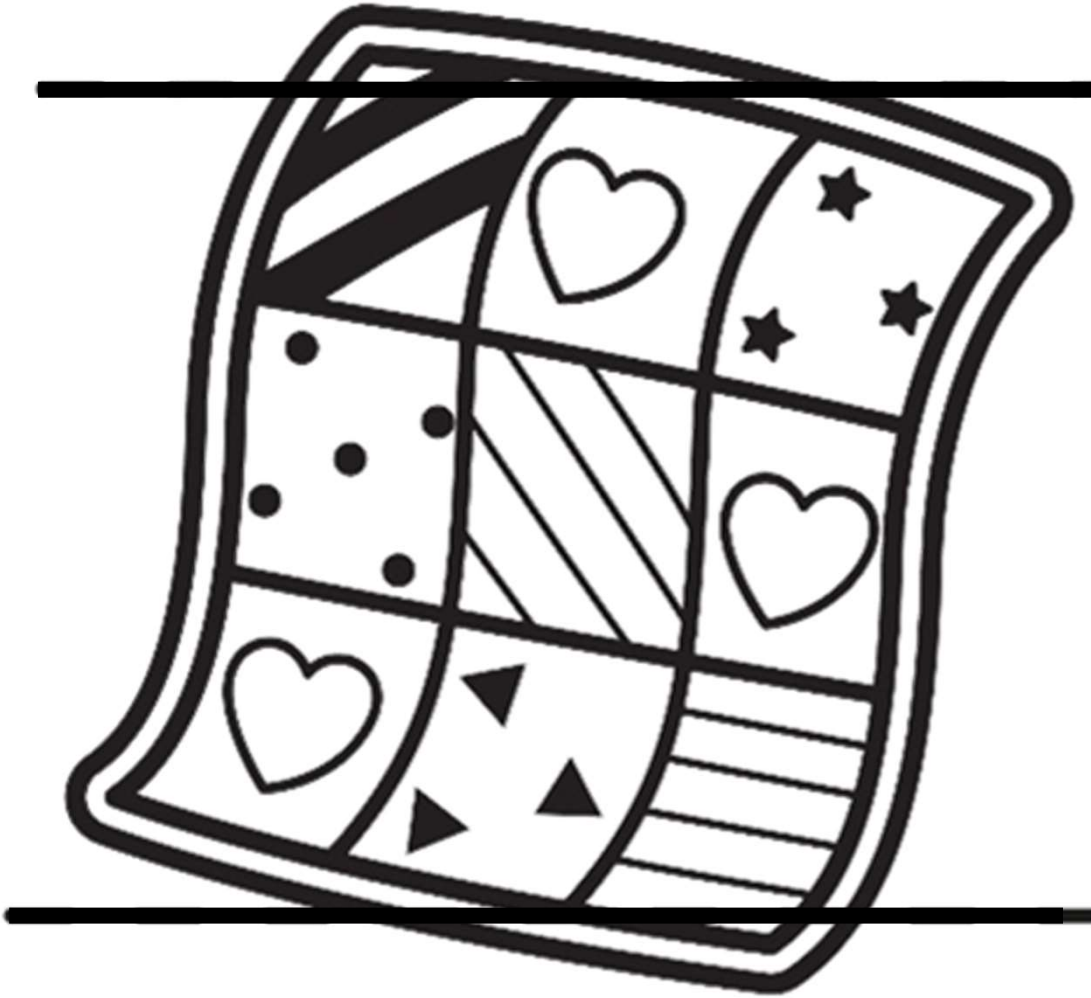



Sense and MomAbility's
12 Days of Christmas



R is for

riboon

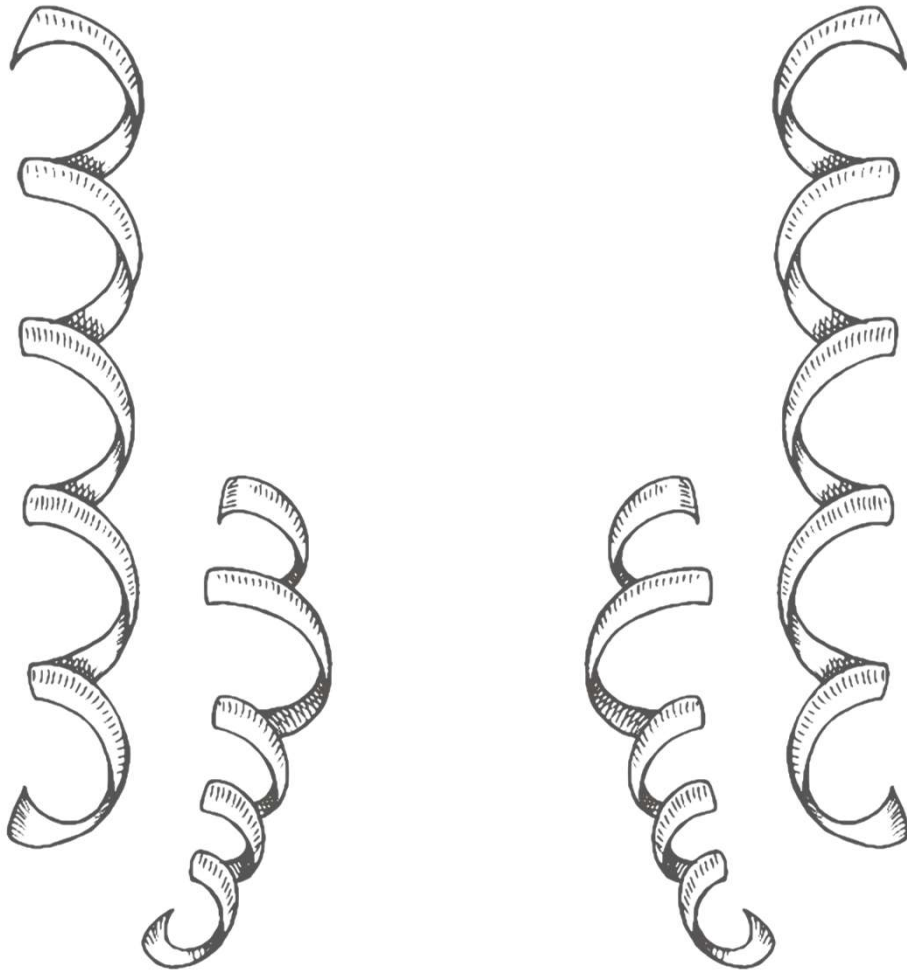



Sense and MomAbility's
12 Days of Christmas



S is for

—
- - - - -
snowflakes
—

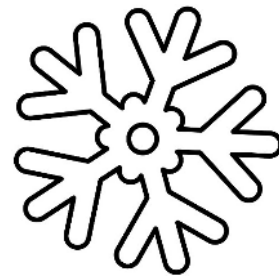
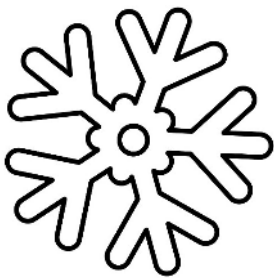

Sense and MomAbility's
12 Days of Christmas



T is for

tree



Sense and MomAbility's
12 Days of Christmas



U is for

unwrap

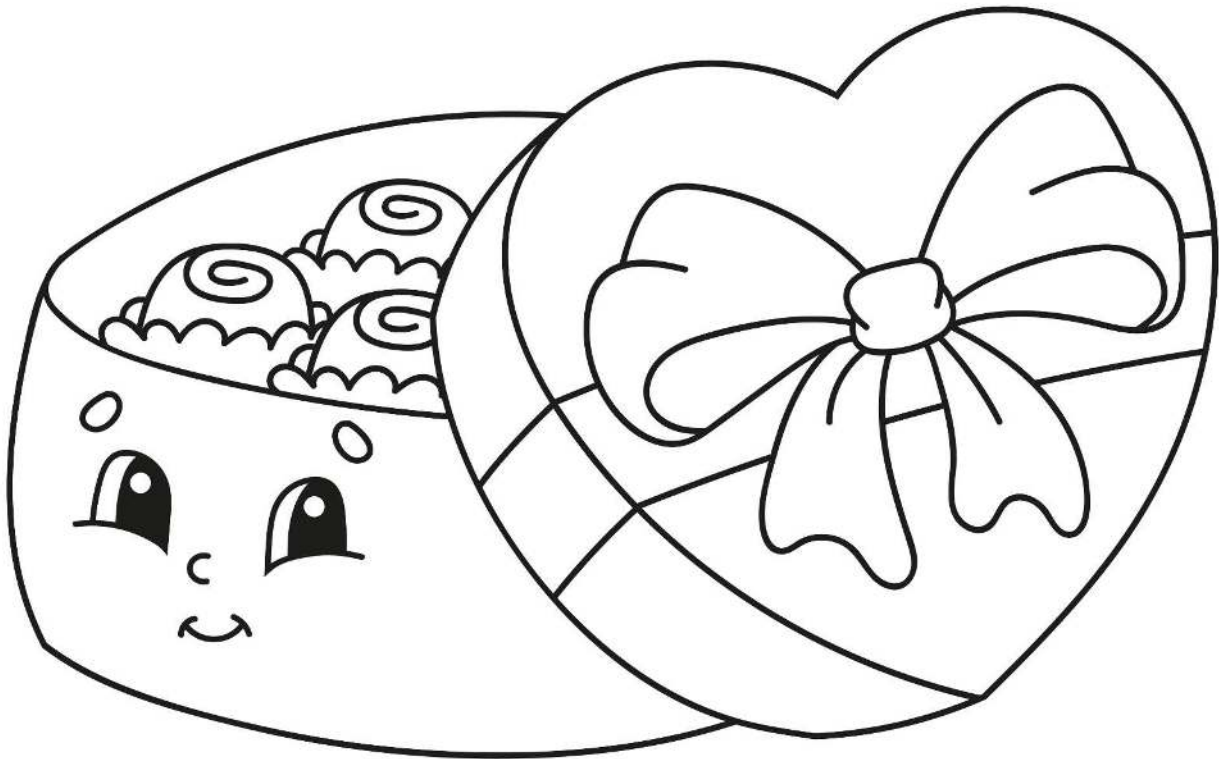



Sense and MomAbility's
12 Days of Christmas



V is for

vacation

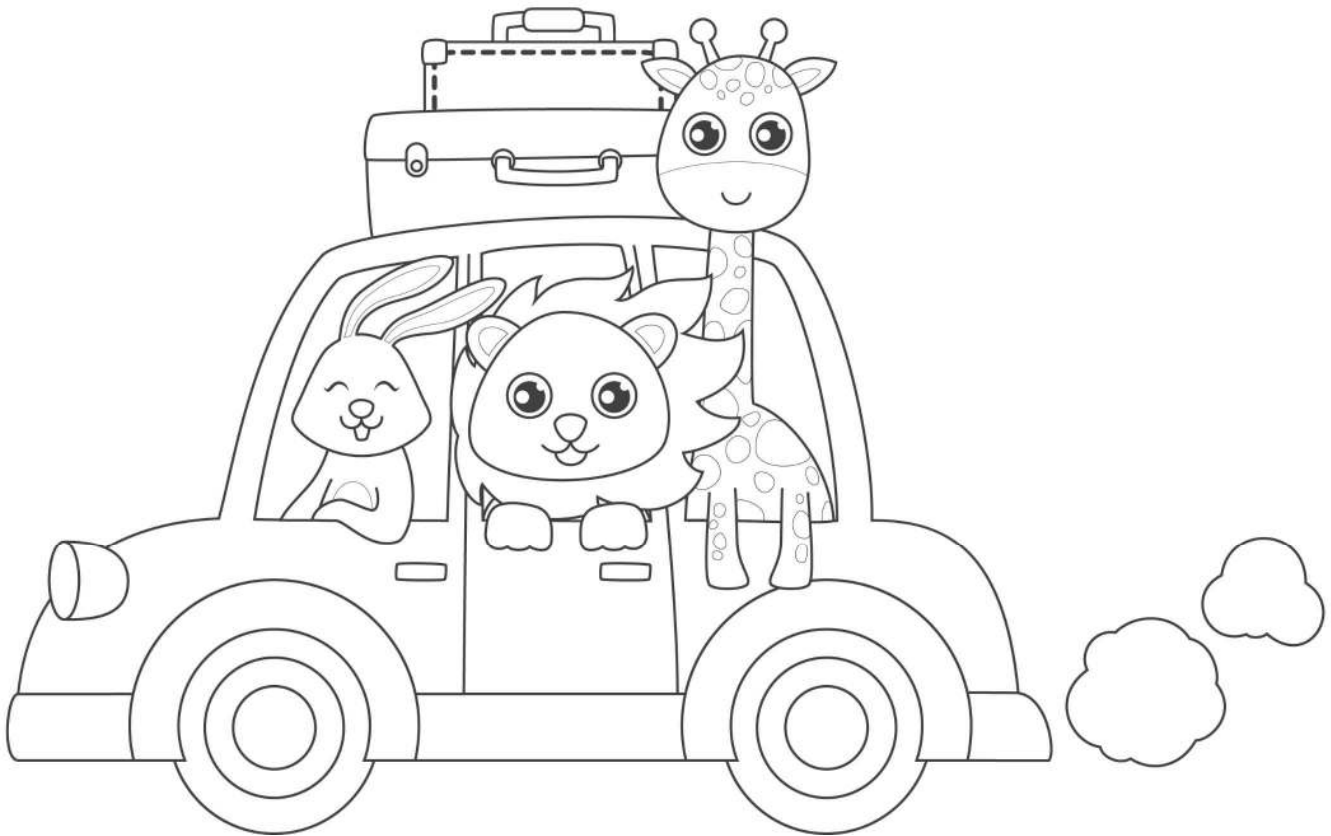

Sense and MomAbility's
12 Days of Christmas



W is for

wreath





Sense and MomAbility's
12 Days of Christmas



X is for

X-mas





Sense and MomAbility's
12 Days of Christmas



Y is for

year

HAPPY NEW YEAR





Sense and MomAbility's
12 Days of Christmas



Z is for

zipper

